

MONITOR SIGNAGE UHD

LS95D
98"

UH5C
65" | 55" | 49"

UH5C
86" | 75"

UM3C
75"



		98LS95D
PANEL	Screen Size	98"
	Panel Technology	IPS
	Aspect Ratio	16:9
	Native Resolution	3,840 x 2,160 (UHD)
	Brightness	500cd/m ² (Typ)
	Contrast Ratio	1,300:1
	Viewing Angle (H x V)	178 x 178
	Response Time	8ms (G to G BW) typ.
	Surface Treatment	Hard coating (3H), Anti-glare treatment of the front polarizer (Haze 1% (Typ.))
	Operation Hours	24 hrs
Orientation	Landscape & Portrait	
CONNECTIVITY	Input	HDMI (3), DP, DVI-D, Audio in
	Output	DP, Audio out, External speaker out
	External Control	RS232C in/out, RJ45, IR receiver, Pixel sensor, USB 3.0, USB 2.0, SD card
PHYSICAL SPECIFICATION	Bezel Color	Black
	Bezel Width	14.9 mm (Even bezel)
	Monitor Dimension (W x H x D)	2,191.8 x 1,246.8 x 69.4 mm
	Weight	88 kg
	Carton Dimensions (W x H x D)	2,342 x 1,386 x 402 mm
	Packed Weight	123 kg
	Handle	No
VESA™ Standard Mount Interface	800 x 400 mm	
SPECIAL FEATURES	Temperature sensor, Auto brightness sensor, Tile mode (up to 15x15), Natural mode @Tile mode, DPM select, DPM wake up, Energy saving, Smart Energy saving, File play with USB, PIP/PBP (2, 3, 4), Internal memory (8 GB), USB cloning, Fail over, Mirroring, SoftAP, Beacon, DP daisy chain	
ENVIRONMENT CONDITIONS	Operation Temperature	0°C to 40°C
	Operation Humidity	10% to 80%
POWER	Power Supply	100-240 V~, 50/60 Hz
	Power Type	Built-In Power
	Power Consumption	Typ./Max Smart Energy Saving 450 W 315 W
STANDARD (CERTIFICATION)	Safety	UL / cUL / CB / TUV / KC
	EMC	FCC Class "A" / CE / KCC
	ErP / Energy Star / CEL	No / No / Yes
MEDIA PLAYER COMPATIBILITY	OPS Type Compatible	No
	External Media player Attachable	Yes (MP500/MP700)
SOFTWARE COMPATIBILITY	SuperSign W/Lite	Yes
	SuperSign C	Yes
ACCESSORIES	Basic	Remote controller (include battery 2ea), Power cord, IR/Light sensor receiver, CD (Owner's manual, SuperSign program / Manual), HDMI 2.0 cable, DP cable, RS232C, Wi-Fi dongle, Eye bolt
	Optional	SP-2200 (External speaker)
EAN	8806084842015	

Conessioni

- ❶ SPEAKER OUT
- ❷ LAN
- ❸ AUDIO IN
- ❹ AUDIO OUT
- ❺ DP OUT
- ❻ DVI-D IN
- ❼ PIXEL SENSOR
- ❽ IR & LIGHT SENSOR
- ❾ DP IN
- ❿ HDMI IN
- ⓫ USB 3.0
- ⓬ SD CARD
- ⓭ RS-232C IN
- ⓮ RS-232C OUT
- ⓯ USB 2.0

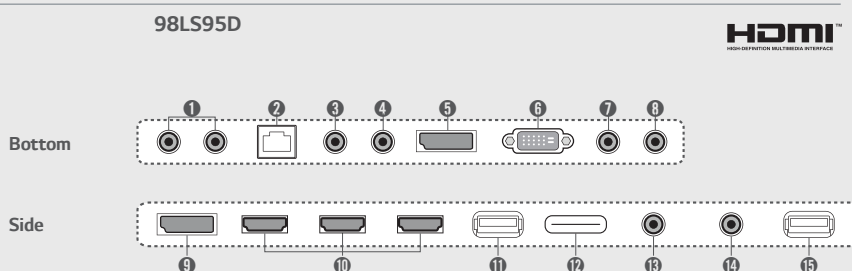

98"

2,191.8 x 1,246.8 x 69.4 / 88 kg

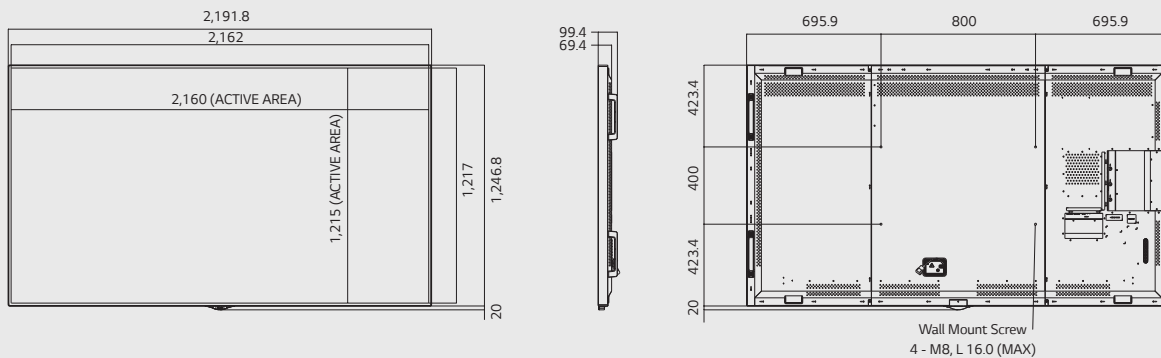

		86UH5C	75UH5C
PANEL	Screen Size	86"	75"
	Panel Technology	IPS	IPS
	Aspect Ratio	16 : 9	16 : 9
	Native Resolution	3,840 x 2,160 (UHD)	3,840 x 2,160 (UHD)
	Brightness	500cd/m ²	500cd/m ²
	Contrast Ratio	1,200:1	1,200:1
	Dynamic CR	4,000,000:1	4,000,000:1 (DTV Label only)
	Viewing Angle (H x V)	178 x 178	178 x 178
	Response Time	8ms(G to G)	6ms (G to G)
	Surface Treatment	Low Haze 3%	Low Haze 3%
Life Time (Min.)	50,000 Hrs	50,000 Hrs	
Operation Hours	24 Hours	24 Hrs	
Orientation	Portrait & Landscape	Portrait & Landscape	
CONNECTIVITY	Input	HDMI, DP, DVI-D, Audio, USB 3.0, SD Card	HDMI, DP, DVI-D, Audio, USB 3.0, SD Card
	Output	DP, Audio	DP, Audio
	External Control	RS232C, RJ45, IR Receiver, Pixel Sensor	RS232C, RJ45, IR Receiver, Pixel Sensor
PHYSICAL SPECIFICATION	Bezel Color	Black	Black
	Bezel Width	14.7mm	14.9mm
	Monitor Dimension (W x H x D)	1,926.2 x 1,097.2 x 60.6mm (without logo / handle)	1,682.4 x 960.3 x 39.7mm (without logo / handle)
	Weight (Head)	49kg	41.5kg
	Carton Dimensions (W x H x D)	2,073 x 1,260 x 292mm	1,816 x 1,123 x 228mm
	Packed Weight	61.1kg	49.5kg
VESA™ Standard Mount Interface	600 x 400mm	600 x 400mm	
SPECIAL FEATURES	Temperature Sensor, Auto Brightness Sensor, Tile Mode (up to 15x15), Natural Mode@Tile Mode, ISM Method, Internal Memory (8GB, System 4GB), Wi-Fi built-in (802.11n), USB Cloning, Content Scheduling, Sync mode, PM mode, Fail Over, Wake on LAN, BEACON (On/Off), Embedded Template, PIP/PBP (2/3/4)		
ENVIRONMENT CONDITIONS	Operation Temperature Range	0 °C to 40 °C	0 °C to 40 °C
	Operation Humidity Range	10 % to 80 %	10 % to 80 %
POWER	Power Supply	100-240V~, 50/60Hz	100-240V~, 50/60Hz
	Power Type	Built-In Power	Built-In Power
	Power Typ.	275W	240W
	Consumption Smart Energy Saving	193W	170W
STANDARD (CERTIFICATION)	Safety	UL / cUL / CB / TUV / KC	UL / cUL / CB / TUV / KC
	EMC	FCC Class "A" / CE / KCC	FCC Class "A" / CE / KCC
	ErP / Energy Star	No / No	No / No
MEDIA PLAYER COMPATIBILITY	OPS Type Compatible	Yes	Yes
	External Media Player Attachable	Yes (MP500 / MP700)	Yes (MP500 / MP700)
SOFTWARE COMPATIBILITY	SuperSign W/Lite	Yes	Yes
	SuperSign C	Yes	Yes
ACCESSORY	Basic	Remote Controller (include battery 2ea), Power Cord, QSG, DP cable (2.6M), Regulation Book, Phone to RS232C Gender, Memory Cover	Remote Controller (include 2ea batteries), Power Cord, QSG, DP 1.8M, Regulation Book, Phone to RS232C Gender, Memory Cover
	Optional	Pixel Sensor (KT-SP0), Media Player, OPS Kit (KT-OPSA), HDBaseT (EB-B100)	Pixel Sensor (KT-SP0), Media Player, OPS Kit (KT-OPSA), HDBaseT (EB-B100)
EAN		8806087659634	8806087566727

Conessioni

86UH5C / 75UH5C



- 1 LAN
- 2 AUDIO IN
- 3 AUDIO OUT
- 4 DP OUT
- 5 DVI-D IN
- 6 PIXEL SENSOR
- 7 IR & LIGHT SENSOR
- 8 DP IN
- 9 HDMI IN 3
- 10 HDMI IN 2
- 11 HDMI IN 1
- 12 USB 3.0 IN
- 13 SD CARD
- 14 RS-232C IN
- 15 RS-232C OUT

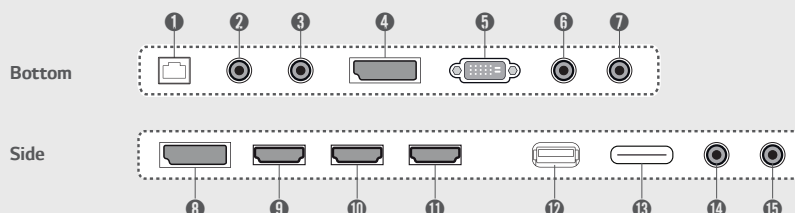

86"

1,926.2 x 1,101.2* x 63.6*mm / 49kg (Without handle)

1,926.2 x 1,101.2* x 78.3*mm (With handle)

*With LG logo

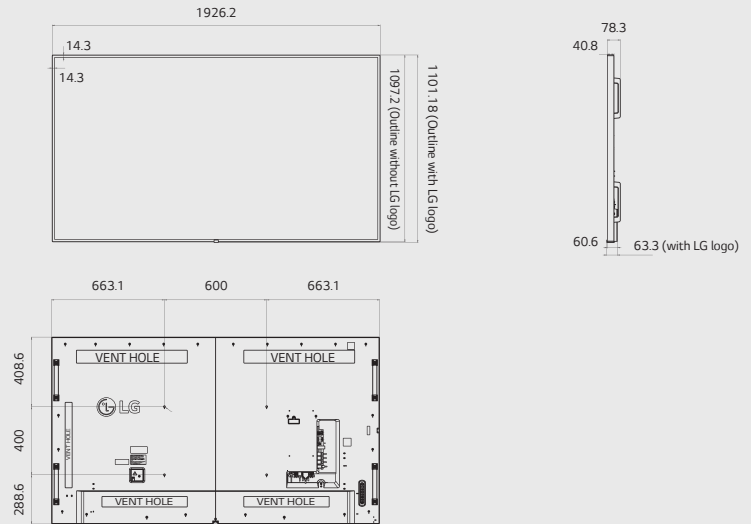

75"

1,682.4 x 963.3* x 57.9* mm / 41.5kg (Without handle)

1,682.4 x 963.3* x 73.9* mm (With handle)

* With LG logo

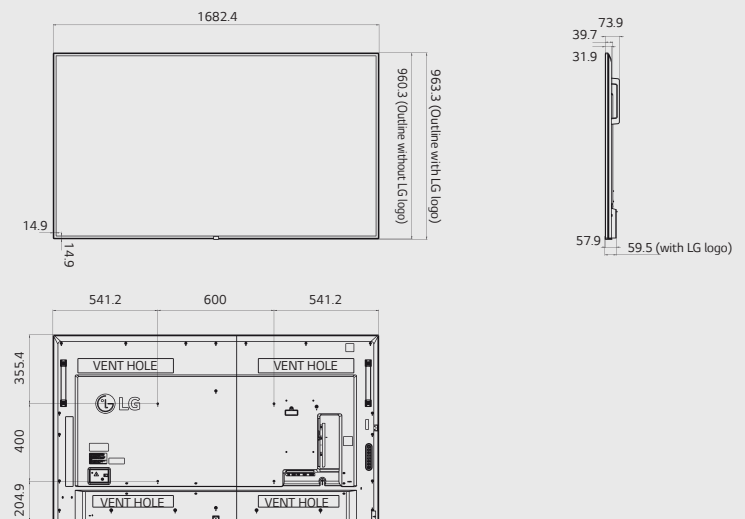

		65UH5C	55UH5C	49UH5C
PANEL	Screen Size	65"	55"	49"
	Panel Technology	IPS	IPS	IPS
	Aspect Ratio	16:9	16:9	16:9
	Native Resolution	3,840 x 2,160 (UHD)	3,840 x 2,160 (UHD)	3,840 x 2,160 (UHD)
	Brightness	500 cd/m ²	500 cd/m ²	500 cd/m ²
	Contrast Ratio	1,000:1	1,100:1	1,100:1
	Dynamic CR	1,000,000:1	1,000,000:1	1,000,000:1
	Viewing Angle (H x V)	178 x 178	178 x 178	178 x 178
	Response Time	8ms (G to G)	8ms (G to G)	8ms (G to G)
	Surface Treatment	Low Haze 1%	Low Haze 1%	Low Haze 1%
	Life Time (Min.)	50,000 hours (Typ.)	50,000 hours (Typ.)	50,000 hours (Typ.)
Operation Hours	24 hours	24 hours	24 hours	
Orientation	Portrait & Landscape	Portrait & Landscape	Portrait & Landscape	
CONNECTIVITY	Input	HDMI, DP, DVI-D, Audio, USB 3.0, SD Card		
	Output	DP, Audio, External Speaker Out		
	External Control	RS232C, RJ45, IR Receiver, Pixel Sensor		
PHYSICAL SPECIFICATION	Bezel Color	Black	Black	Black
	Bezel Width	12.1 mm (T), 12.6 mm (R/L), 15.7 mm (B)	12.1 mm (T), 12.6 mm (R/L), 15.7 mm (B)	11.9 mm (T), 12.4 mm (R/L), 15.5 mm (B)
	Monitor Dimension (W x H x D)	1,458.6 x 848.9 x 40.1 mm	1,239.8 x 725.2 x 38.6 mm	1,103.2 x 648.0 x 38.6 mm
	Weight (Head)	26.0 kg	16.6 kg	13.3 kg
	Carton Dimensions (W x H x D)	1,561 x 971 x 190 mm	1,330 x 807 x 170 mm	1,197 x 760 x 166 mm
	Packed Weight	32.5 kg	21.1 kg	17.7 kg
	VESA™ Standard Mount Interface	300 x 300 mm	300 x 300 mm	300 x 300 mm
SPECIAL FEATURES	Temperature Sensor, Auto Brightness Sensor, Tile Mode (up to 15x15), Natural Mode@Tile Mode, ISM Method, Internal Memory (8GB, System 4GB), Wi-Fi built-in (802.11n), USB Cloning, Content Scheduling, Sync mode, PM mode, Fail Over, Wake on LAN, BEACON (On/Off), Embedded Template, PIP/PBP			
ENVIRONMENT CONDITIONS	Operation Temperature Range	0°C to 40°C	0°C to 40°C	0°C to 40°C
	Operation Humidity Range	10% to 80%	10% to 80%	10% to 80%
POWER	Power Supply	100-240 V~, 50/60 Hz	100-240 V~, 50/60 Hz	100-240 V~, 50/60 Hz
	Power Type	Built-In Power	Built-In Power	Built-In Power
	Power Typ.	134 W	116 W	102 W
	Consumption Smart Energy Saving	90 W	80 W	70 W
STANDARD (CERTIFICATION)	Safety	UL / cUL / CB / TUV / KC	UL / cUL / CB / TUV / KC	UL / cUL / CB / TUV / KC
	EMC	FCC Class "A" / CE / KCC	FCC Class "A" / CE / KCC	FCC Class "A" / CE / KCC
	ErP / Energy Star	NA / EPA7.0	NA / EPA7.0	NA / EPA7.0
MEDIA PLAYER COMPATIBILITY	OPS Type Compatible	Yes	Yes	Yes
	External Media Player Attachable	Yes (MP500 / MP700)	Yes (MP500 / MP700)	Yes (MP500 / MP700)
SOFTWARE COMPATIBILITY	SuperSign W/Lite	Yes	Yes	Yes
	SuperSign C	Yes	Yes	Yes
ACCESSORIES	Basic	Remote Controller (2ea batteries included), Power cord, QSG, HDMI cable, Regulation book, Phone to RS232C gender, Memory cover	Remote Controller (2ea batteries included), Power cord, QSG, HDMI cable, Regulation book, Phone to RS232C gender, Memory cover	Remote Controller (2ea batteries included), Power cord, QSG, HDMI cable, Regulation book, Phone to RS232C gender, Memory cover
	Optional	Speaker (SP-5200), Stand (ST-651T), Pixel sensor (KT-SPO), Media player, Wall bracket (LSW350B), VESA Adapter (AM-B330S), OPS Kit (KT-OPSA), HDBaseT (EB-B100)	Speaker (SP-5200), Stand (ST-201T), Pixel sensor (KT-SPO), Media player, Wall bracket (LSW350B), VESA Adapter (AM-B330S), OPS Kit (KT-OPSA), HDBaseT (EB-B100)	Speaker (SP-5200), Stand (ST-201T), Pixel sensor (KT-SPO), Media player, Wall bracket (LSW350B), VESA Adapter (AM-B330S), OPS Kit (KT-OPSA), HDBaseT (EB-B100)
EAN	8806087806311	8806087806038	8806087803624	

Conessioni

- 1 SPEAKER OUT
- 2 IR & LIGHT SENSOR
- 3 PIXEL SENSOR
- 4 HDMI 1
- 5 HDMI 2
- 6 LAN
- 7 AUDIO IN
- 8 AUDIO OUT
- 9 DVI-D IN
- 10 DP IN
- 11 DP OUT
- 12 SD Card
- 13 USB 3.0
- 14 RS-232C IN
- 15 RS-232C OUT

65UH5C / 55UH5C / 49UH5C

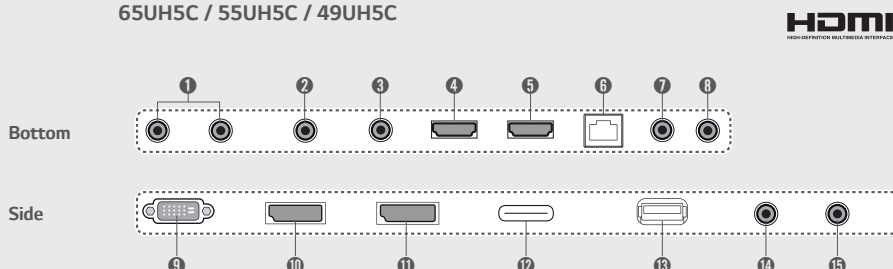

65"

1458.6 x 848.9 x 40.1 / 26.0

Kg

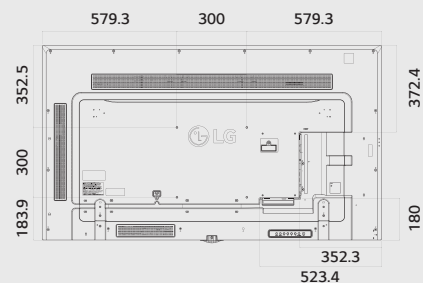
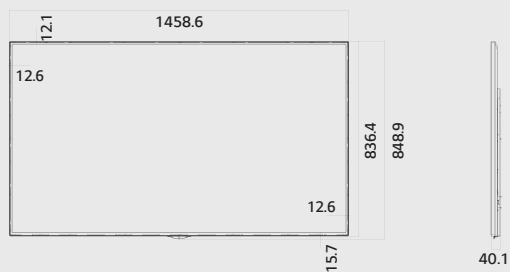

55"

1239.8 x 725.2 x 38.6 /

16.6 kg

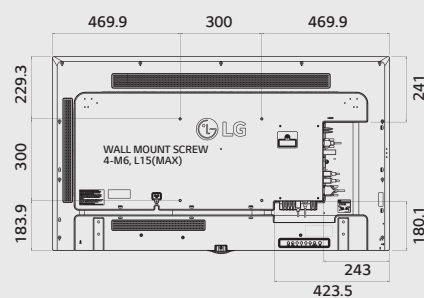
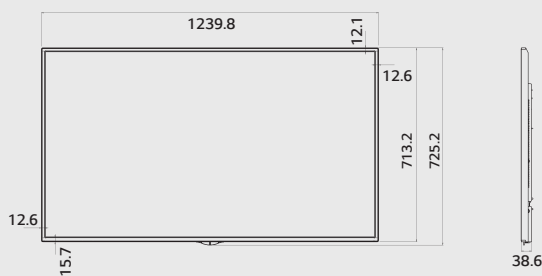

49"

1103.2 x 648 x 38.6 /

13.3 kg

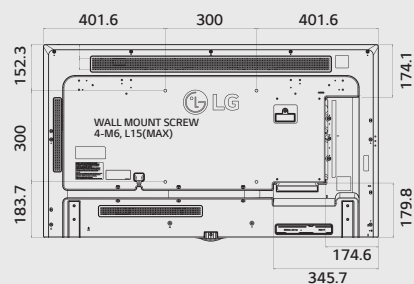
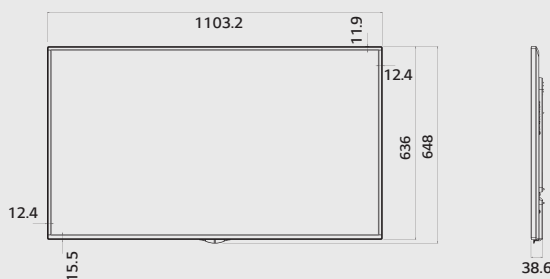

		84WS70MD
PANEL	Screen Size	84"
	Panel Technology	IPS
	Aspect Ratio	16:9
	Native Resolution	3,840 x 2,160 (UHD)
	Brightness	500 cd/m ² (Typ)
	Contrast Ratio	1,400:1
	Viewing Angle (H x V)	178 x 178
	Response Time	12ms (G to G) typ.
	Surface Treatment	Hard coating (3H), Anti-glare treatment of the front polarizer (Haze 10% (Typ.))
Operation Hours	24 hrs	
Orientation	Landscape & Portrait	
CONNECTIVITY	Input	HDMI (3), DP, DVI-D, Audio in
	Output	DP, Audio out, External speaker out
	External Control	RS232C in/out, RJ45, Pixel sensor, USB 3.0, USB 2.0, SD card
PHYSICAL SPECIFICATION	Bezel Color	Black
	Bezel Width	27.9 mm (Even bezel)
	Monitor Dimension (W x H x D)	1,923 x 1,109 x 51 mm (Including Handle: 101 mm)
	Weight	72.9 kg
	Carton Dimensions (W x H x D)	2,034 x 1,213 x 314 mm
	Packed Weight	86.7 kg
	Handle	Yes
VESA™ Standard Mount Interface	600 x 400 mm	
SPECIAL FEATURES	Temperature sensor, Auto brightness sensor, Tile mode (up to 15x15), Natural mode @Tile mode, DPM select, DPM wake up, Energy saving, Smart Energy saving, File play with USB, PIP/PBP (2, 3, 4), Internal memory (8 GB), USB cloning, Fail over, Mirroring, SoftAP, Beacon, DP daisy chain	
ENVIRONMENT CONDITIONS	Operation Temperature	0°C to 40°C
	Operation Humidity	10% to 80%
POWER	Power Supply	100-240 V~, 50/60 Hz
	Power Type	Built-In Power
	Power Consumption	Typ./Max Smart Energy Saving
STANDARD (CERTIFICATION)	Safety	UL / cUL / CB / TUV / KC
	EMC	FCC Class "A" / CE / KCC
	ErP / Energy Star / CEL	No / No / Yes
MEDIA PLAYER COMPATIBILITY	OPS Type Compatible	No
	External Media player Attachable	No
SOFTWARE COMPATIBILITY	SuperSign W/Lite	Yes
	SuperSign C	Yes
ACCESSORIES	Basic	Power cord, Remote controller (include battery 2ea), CD (Manual/Elite-C/ESG), Eye bolt (2ea), HDMI cable
	Optional	SP-2100 (External speaker)
EAN	8806084267085	

Conessioni

- ❶ SPEAKER OUT
- ❷ LAN
- ❸ AUDIO IN
- ❹ AUDIO OUT
- ❺ DP OUT
- ❻ DVI-D IN
- ❼ PIXEL SENSOR
- ❽ IR & LIGHT SENSOR
- ❾ DP IN
- ❿ HDMI IN
- ⓫ USB 3.0
- ⓬ SD CARD
- ⓭ RS-232C IN
- ⓮ RS-232C OUT
- ⓯ USB 2.0

84WS70MD

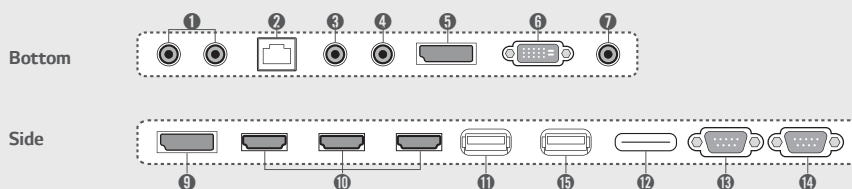

84"

1,923 x 1,109 x 51 mm / 72.9 kg

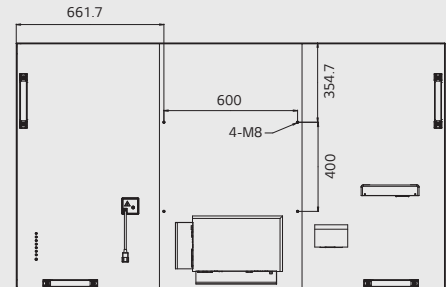
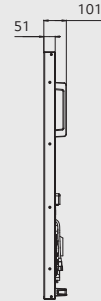
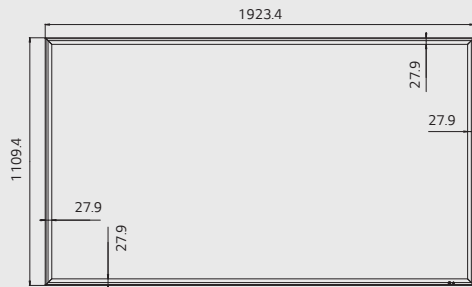

		84WS70BD
PANEL	Screen Size	84"
	Panel Technology	IPS
	Aspect Ratio	16:9
	Native Resolution	3,840 x 2,160 (UHD)
	Brightness	350 cd/m ² (Typ)
	Contrast Ratio	1,400:1
	Viewing Angle (H x V)	178 x 178
	Response Time	5ms (G to G BW) typ.
	Surface Treatment	Hard coating (3H), Anti-glare treatment of the front polarizer (Haze 10% (Typ.))
	Operation Hours	16 hrs
Orientation	Landscape	
CONNECTIVITY	Input	HDMI (3), DP, DVI-D, Audio in
	Output	DP, Audio out, External speaker out
	External Control	RS232C in/out, RJ45, Pixel sensor, USB 3.0, USB 2.0, SD card
PHYSICAL SPECIFICATION	Bezel Color	Black
	Bezel Width	27.9 mm (Even bezel)
	Monitor Dimension (W x H x D)	1,923 x 1,109 x 51 mm (Including Handle: 101 mm)
	Weight	72.9 kg
	Carton Dimensions (W x H x D)	2,034 x 1,213 x 314 mm
	Packed Weight	86.7 kg
	Handle	Yes
VESA™ Standard Mount Interface	600 x 400 mm	
SPECIAL FEATURES	Temperature sensor, Auto brightness sensor, Tile mode (up to 15x15), Natural mode @Tile mode, DPM select, DPM wake up, Energy saving, Smart Energy saving, File play with USB, PIP/PBP (2, 3, 4), Internal memory (8 GB), USB cloning, Fail over, Mirroring, SoftAP, Beacon, DP daisy chain	
ENVIRONMENT CONDITIONS	Operation Temperature	0°C to 40°C
	Operation Humidity	10% to 80%
POWER	Power Supply	100-240 V~, 50/60 Hz
	Power Type	Built-In Power
	Power Consumption	Typ./Max Smart Energy Saving 450 W 300 W
STANDARD (CERTIFICATION)	Safety	UL / cUL / CB / TUV / KC
	EMC	FCC Class "A" / CE / KCC
	ErP / Energy Star / CEL	No / No / Yes
MEDIA PLAYER COMPATIBILITY	OPS Type Compatible	No
	External Media player Attachable	No
SOFTWARE COMPATIBILITY	SuperSign W/Lite	Yes
	SuperSign C	Yes
ACCESSORIES	Basic	Power cord, Remote controller (include battery 2ea), CD (Manual/Elite-C/ESG), Eye bolt (2ea), HDMI cable
	Optional	SP-2100 (External speaker)
EAN	8806084267351	

Conessioni

- ❶ SPEAKER OUT
- ❷ LAN
- ❸ AUDIO IN
- ❹ AUDIO OUT
- ❺ DP OUT
- ❻ DVI-D IN
- ❼ PIXEL SENSOR
- ❽ IR & LIGHT SENSOR
- ❾ DP IN
- ❿ HDMI IN
- ⓫ USB 3.0
- ⓬ SD CARD
- ⓭ RS-232C IN
- ⓮ RS-232C OUT
- ⓯ USB 2.0

84WS70BD

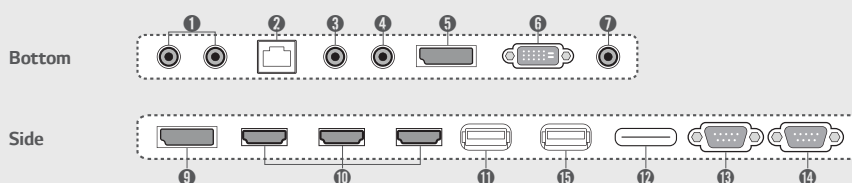

84"

1,923 x 1,109 x 51 mm / 72.9 kg

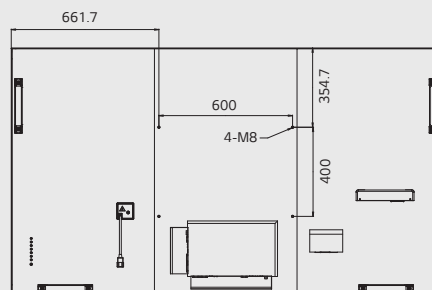
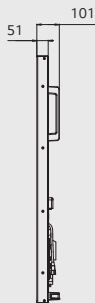
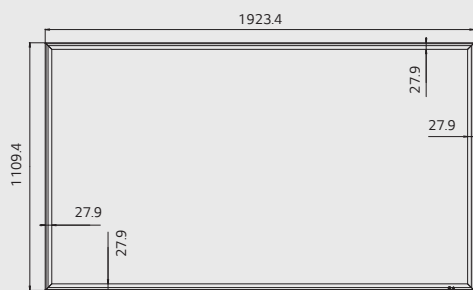

		75UM3C	
PANEL	Screen Size	75"	
	Panel Technology	IPS	
	Aspect Ratio	16 : 9	
	Native Resolution	3,840 x 2,160 (UHD)	
	Brightness	350cd/m ²	
	Contrast Ratio	1,200:1	
	Dynamic CR	2,000,000:1 (DTV Label only)	
	Viewing Angle (H x V)	178 x 178	
	Response Time	6ms (G to G)	
	Surface Treatment	Low Haze 3%	
	Life time (Min.)	50,000 Hours	
	Guaranteed Operation Hours	24 Hours	
CONNECTIVITY	Orientation	Portrait & Landscape	
	Input	HDMI, DP, DVI-D, Audio, USB 3.0, SD Card	
	Output	DP, Audio	
PHYSICAL SPECIFICATION	External Control	RS232C, RJ45, IR Receiver, Pixel Sensor	
	Bezel Color	Black	
	Bezel Width	On: 15.8mm, Off: 14.9mm	
	Monitor Dimension (W x H x D)	1,682.37 x 960.3 x 39.7mm	
	Weight (Head)	41.5kg	
	Carton Dimensions (W x H x D)	1,816 x 1,123 x 228mm	
	Packed Weight	49kg	
	VESA™ Standard Mount Interface	600 x 400mm	
	SPECIAL FEATURES	Temperature Sensor, Auto Brightness Sensor, Tile Mode (up to 15x15), Natural Mode@Tile Mode, ISM Method, Internal Memory, Wi-Fi built-in, USB Cloning, Contents Scheduling, Sync mode, PM mode, Fail Over, Wake on LAN, BEACON (On/Off), Embedded Template	
	ENVIRONMENT CONDITIONS	Operation Temperature Range	0 °C to 40 °C
		Operation Humidity Range	10 % to 80 %
	POWER	Power Supply	100-240V~, 50/60Hz
Power Type		Built-In Power	
Power Typ. Consumption Smart Energy Saving		160W 115W	
STANDARD (CERTIFICATION)	Safety	UL / cUL / CB / TUV / KC	
	EMC	FCC Class "A" / CE / KCC	
	ErP / Energy Star	NA / No	
MEDIA PLAYER COMPATIBILITY	OPS type compatible	Yes	
	External Media player Attachable	Yes (MP500/MP700)	
SOFTWARE COMPATIBILITY	SuperSign W/Lite	Yes	
	SuperSign C	Yes	
ACCESSORY	Basic	Remote Controller (include 2ea batteries), Power Cord, QSG, DP Cable (1.8M), Regulation Book, Phone to RS232C Gender, Memory Cover	
	Optional	Pixel sensor (KT-SP0), Media player, OPS Kit (KT-OPSA), HDBaseT (EB-B100)	
EAN		8806087657821	

Conessioni

- 1 LAN
- 2 AUDIO IN
- 3 AUDIO OUT
- 4 DP OUT
- 5 DVI-D IN
- 6 PIXEL SENSOR
- 7 IR & LIGHT SENSOR
- 8 DP IN
- 9 HDMI IN 2
- 10 HDMI IN 1
- 12 USB 3.0 IN
- 13 SD CARD
- 14 RS-232C IN
- 15 RS-232C OUT

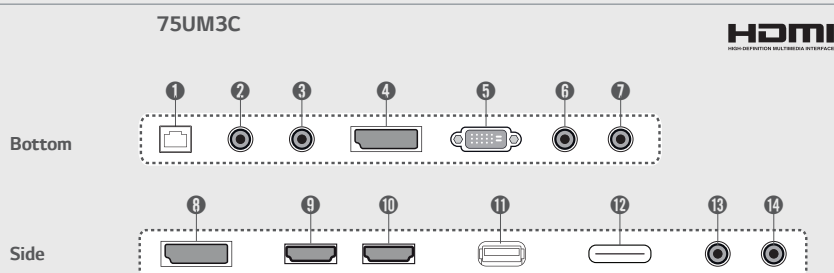

75"

1682.4 x 963.3 x 59.5mm / 41.5kg (without Handle)

1682.4 x 963.3 x 73.9mm (with Handle)

* with LG logo

